

User Guide

SXOBH SERIES HIGH BRIGHT OUTDOOR DISPLAY



SYSTEM INSTALLATION AND ELECTRICAL REQUIREMENTS

Electrical Code

Note: To the display system installer: This reminder is provided to call attention to Article 820-44 of the National Electric Code that provides guidelines for proper grounding and, in particular, specifies that the cable ground shall be connected to the grounding system of the facility. Outlet shall be installed near the equipment and shall be easily accessible.

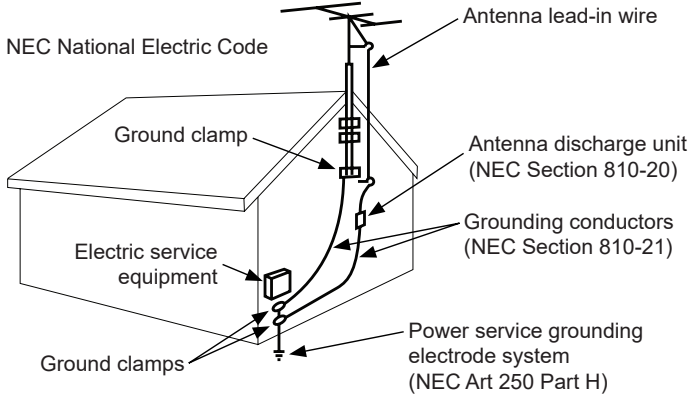

Note: Installation shall incorporate UL Listed external surge protection rated 2500 Vpk or less, for 150 to 300 Vac mains, installed in accordance with Article 285 of ANSI/NFPA 70 or applicable local codes.

Power Source

The display must be connected to a mains socket outlet with a protective grounding connection.

The mains plug is used as the disconnect device and shall remain readily accessible.

Electrical installation shall be in accordance with the applicable parts of Chapter 8 of ANSI/NFPA 70.

An outdoor antenna should not be located near overhead electrical lines or any electrical circuits.

If an outside antenna is connected to the receiver, confirm that the antenna system is grounded to protect against voltage surges and built up static charges. Section 810 of the National Electric Code, ANSI/NFPA No 70-1984, provides information with respect to proper grounding for the mast and supporting structure, grounding of the lead-in wire to an antenna discharge unit, size of grounding connectors, location of antenna discharge unit, connection to grounding electrodes and requirements for the grounding electrode.

This display operates on 100-240 volts 50-60 Hz, AC current. Insert the power cord into a 120 volt 60 Hz outlet. Never connect the display to direct current or anything other than the specified voltage.

To prevent electric shock from the display, do not use with an extension cord, receptacle, or other outlet unless the blades and ground terminal can be fully inserted to prevent blade exposure.

All secondary lines must be routed through grounded conduit and kept separate from AC line.

FCC CAUTION

To assure continued compliance and possible undesirable interference, ferrite cores may be used when connecting this display to video equipment; maintain at least 400mm (15.75 inches) spacing to other peripheral devices.

FCC STATEMENT

This equipment has been tested and found to comply with the limits for a Class A digital device, pursuant to Part 15 of the FCC Rule. These limits are designed to provide reasonable protection against harmful interference in a residential installation. This equipment generates, uses and can radiate radio frequency energy and, if not installed and used in accordance with these instructions, may cause harmful interference to radio communications; however, there is no guarantee that interference will not occur in a particular installation. If this equipment does cause harmful interference to radio or television reception, which can be determined by turning the equipment off and on, the user is encouraged to try to correct the interference by one or more of the following measures:

1. Reorient or relocate the receiving antenna.
2. Increase the separation between the equipment and receiver.
3. Connect the equipment into an outlet on a circuit different from that to which the receiver is connected.
4. Consult the dealer or an experienced radio/display technician for help.

This device complies with Part 15 of the FCC Rules. Operation is subject to the following two conditions:

- This device may not cause harmful interference.
- This device must accept any interference received, including interference that may cause undesired operation.

Relevant Information

Record your display's model and serial number here for future reference. Keep this user manual in an accessible location in the event service is required.

Note: Your display's serial number can be found on your invoice, on the box, underneath the rear cover plate, and in the Setup Menu under Technical Support.

Model Number _____

Serial Number _____

GENERAL SAFETY PRECAUTIONS

Read before operating equipment

Thank you for purchasing our product. Before using it, please read this user guide carefully and follow the instructions for safe operation. Please keep this manual for future reference and always include it when transferring or transporting this product to a different location.

▲ WARNING

In case of emergency such as fire or electric shock caused by the product, immediately contact 911 or proper emergency police/fire service agencies in your country.

To reduce the risk of electric shock or fire, heed the following:

- In case of product malfunction or unusual events such as electrical burning smell, smoke, or loss of content signals due to internal overheating, immediately turn off, unplug the electrical cord and contact the manufacturer.
- Do not disassemble, modify or service product in any way other than that contained in this instruction. Any unauthorized modifications made to the product automatically void product warranty.
- Do not touch antenna lines or wires, electrical cables or plugs when lightning or thunder is present or with wet hands.
- Do not submerge in water.
- Do not destroy, process, or place close to any heat source.
- Do not install near poisonous gas or chemically unstable atmosphere.
- Do not install near strong magnetic or electrical current field.
- Do not install the product in unstable locations or near moving objects, constantly vibrating equipment, or uneven surfaces.
- Do not leave any fire source, such as candles, close to or on the product.
- Do not operate the product if it has been dropped or struck. Severe physical impact to the product may cause components to fall out of place within and break.
- Do not bend or twist electrical cords, electrical plugs, cables, or wires with excessive force.
- Do not block ventilation slots or place any heavy object on the product.
- Use properly rated electrical voltage.
- Do not use any electrical sockets or power strips with many other devices jointly plugged in. Use a single, directly dedicated and rated GFCI electrical outlet for the product for safe operation.
- Do not move or transport with any cables (electrical, content connectivity) plugged in to the source devices.
- Always connect the electrical plug firmly and completely. When disconnecting any cables, always pull on the plug and not the cord.
- Always leave the power off when plugging or unplugging the electrical cords or connection cables.
- Do not defeat the safety purpose of the polarized or grounding type electrical plug. A polarized plug has two blades with one wider than the other. A grounding type plug has two blades and a third grounding prong. The wide blade or the third prong are provided for your safety. If the provided plug does not fit into your outlet, consult an electrician for replacement of the obsolete outlet.
- Protect the electrical cord from being walked on or pinched particularly at plugs, convenience receptacles, and the point where they exit from the apparatus.

▲ WARNING

- Never apply pressure to the exterior of the LCD screen.
- If monitor or glass is broken, do not come in contact with the liquid crystal and handle with care.
- Do not climb on the product.
- Do not install within five feet from a body of water.
- Do not use if ambient air temperature exceeds the operating limits; Maximum operating temperature is -31°F ~ 140°F (-35°C ~ 60°C).
- High solar loads may require reducing maximum operation temperature up to 14°F (-10°C) to reduce the possibility of temporary screen artifacts.
- Do not install in enclosure or recessed cavity with less than 2 inches of airflow around the display. Air inside fully encased display must be ventilated. Installations within any third party enclosure without written authorization from us are not covered by the Limited Warranty, nor any extended warranty.
- When installing in an enclosure or recessed cavity, the internal temperatures of those locations must not exceed the maximum operating temperatures as listed above.
- The product is to be secured to building before operation.
- Product must be carried and supported by at least two persons.
- Periodically clean dust off the electrical plug to keep it clean and dry, ensuring proper and safe operation.
- Only use attachments/accessories specified by the manufacturer.

CAUTION

To avoid image retention/burn-in on the LCD screen, do not allow static images to display for longer than 20 minutes at a time. Image retention is considered improper use of an LCD and is not covered by the Limited Warranty, nor any extended warranty.

CONTENTS

System Installation and Electrical Requirements	2
Electrical Code	2
Power Source	2
FCC Caution.....	3
FCC Statement.....	3
Relevant Information	3
General Safety Precautions	4
Set Up Instructions	7
Parts List	7
Removing Cord Cover	8
Installing Power Cord	9
Installing IR Extender	9
Installing ALS Extender	9
Connecting Cords.....	10
Replacing Cord Cover	11
Connect to the Power Source	12
Prepare the Display for Mounting.....	13
Remote Control Battery Installation and Replacement	15
Operating Instructions	16
Power On/Off the Display	16
Onboard Controls	16
Navigating the On-Screen Menu	17
Picture	17
Advanced Settings	17
Audio	18
Time	19
Setup	20
System Settings	20
Power Save Mode	20
Backlight.....	21
Pixel Shift	21
Auto Source Switching	22
Lock	23
Media Functionality	24
(RS-232C) Serial Control of the Display	26
Maintenance	27
Care of the Screen	27
Cleaning the Exhaust	27
End of Life Directives	27
Warranty	28

SET UP INSTRUCTIONS

Parts List

Description	Qty
A display	1
B remote	1
C IR extender	1
D regional power cord	3
E 3mm allen wrench	1
F cable tie	3
G user guide (not shown)	1
H technical support insert (not shown)	1

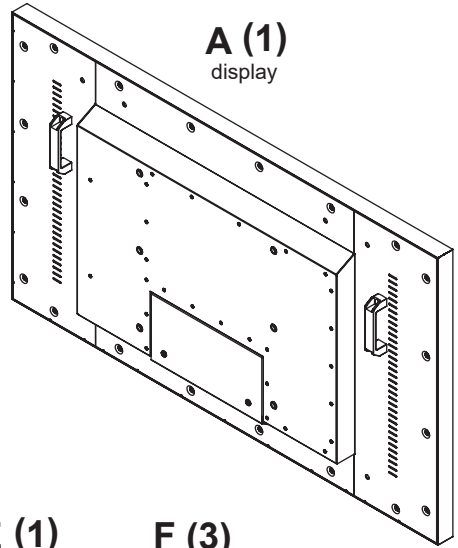

B (1)
remote

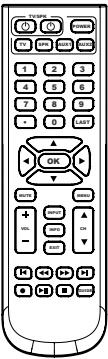

C (1)
IR extender

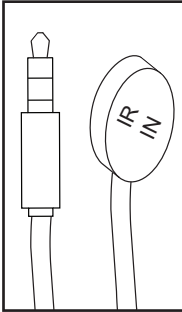

E (1)
3mm allen wrench



F (3)
cable tie

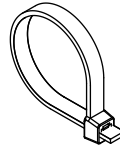

D (3)

regional power cord

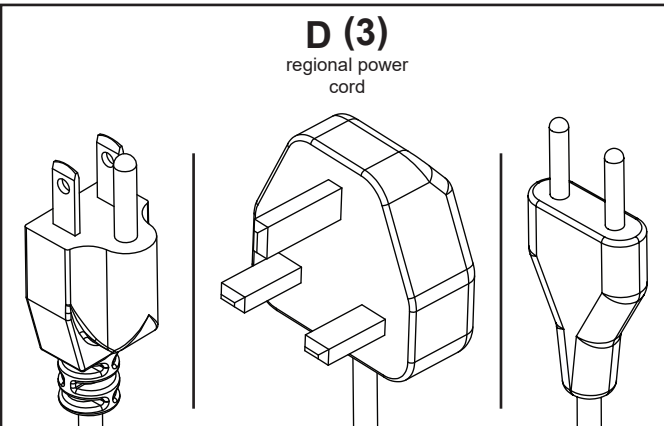

Removing Cord Cover

1. Remove two M5 low-profile hex screws and rear cover plate using 3mm allen wrench. Do not disconnect lanyard.
2. Remove six M5 hex screws and cord cover using 3mm allen wrench.

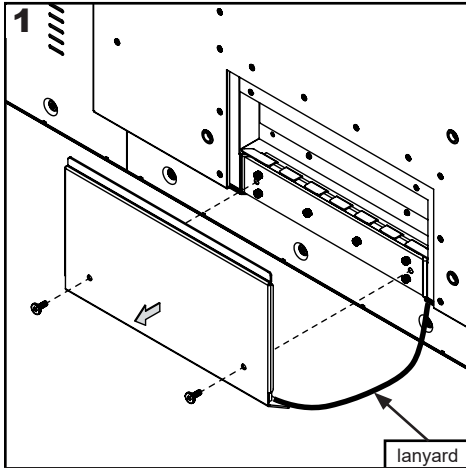

CAUTION

Do not remove lanyard that connects the rear cover plate to the display. Removing the lanyard is considered a modification of the display and will void the warranty.

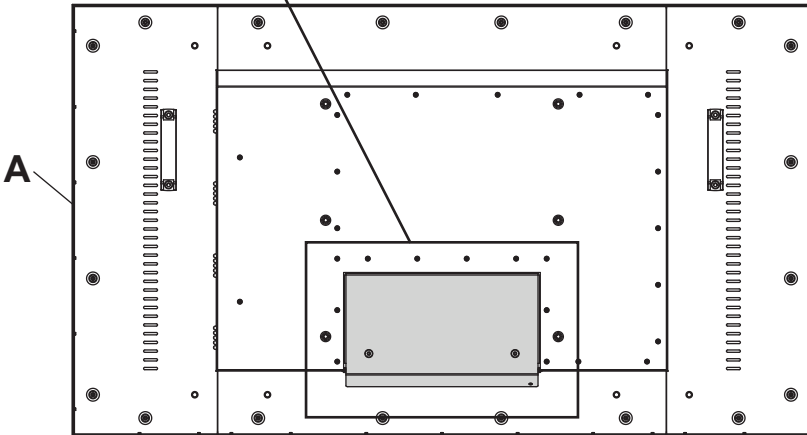
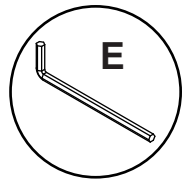
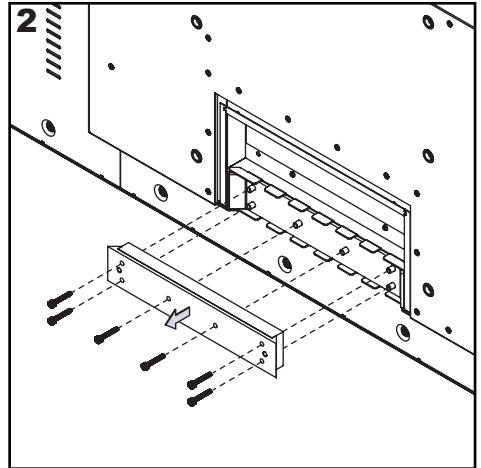

Installing Power Cord

Insert female end of power cord into power port located inside the input compartment.

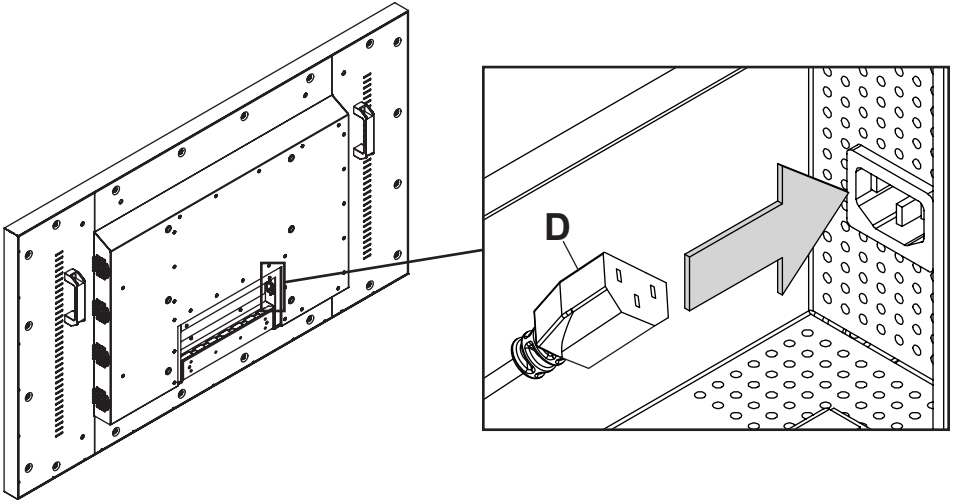

Installing IR Extender (Optional)

Insert the 3.5mm end of the included 5V IR extender into the IR Extender port on the input panel of the display. IR extender port may not be compatible with other third party extenders.

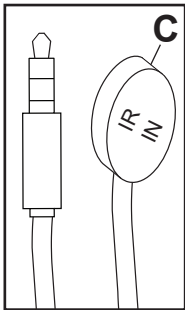

Installing Ambient Light Sensor Extender (Optional)

Insert the 3.5mm end of the Ambient Light Sensor Extender (ACCD-ALS sold separately) into the Ambient Light Sensor Extender port on the input panel of the display. Connecting the Ambient Light Sensor Extender will disable the Ambient Light Sensor that is built into the display.

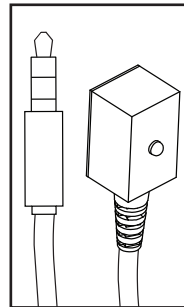

Connecting Cords

Connect source devices to appropriate display input. Make all connections prior to powering on the display. The USB 2.0 Data port is for service and media only. For 5VDC power, use the 5VDC power port.

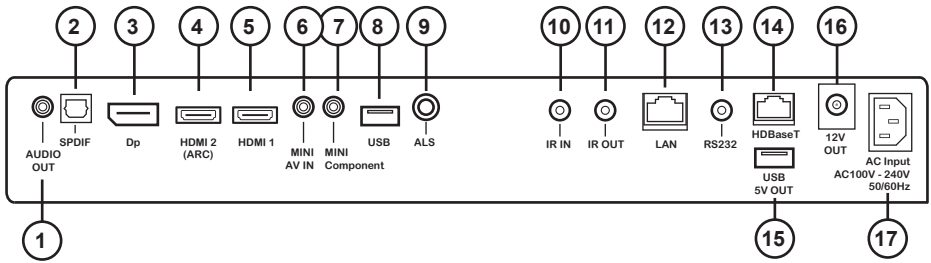

Connection Type	Description
1 Analog Audio Output	Provides Analog Stereo Output
2 S/PDIF Digital Audio Output	Supports Digital Audio
3 DisplayPort Input	Supports FHD Digital AV
4 HDMI2 Input	Supports FHD Digital AV / ARC / peerConnect (CEC)
5 HDMI1 Input	Supports FHD Digital AV / peerConnect (CEC)
6 Mini AV Input	Supports Composite Video and Stereo Audio
7 Mini Component Input	Supports Component Video and Audio
8 USB 2.0 Data Port Input	Supports Text / Photo / Video; Firmware upgrades
9 Ambient Light Extender Input	Ambient light extender sold separately
10 IR Extender Input	Supports the included IR Extender
11 IR Repeater Output	IR emitter/repeater sold separately
12 LAN Port	Supports Network Control and Monitoring
13 RS232C Input	Supports Serial Control of the display, input
14 HDBaseT	Supports Uncompressed Video and Audio; Control and Network not supported.
15 5V DC Output	Supplies 5V DC, 3.5A
16 12V DC Output	Supplies 12V DC, 2.0A
17 AC Input	Supports 100 ~ 240V, 50/60Hz / Region-Specific Power Cord

Replacing Cord Cover

1. Run power and signal cords through separate cable channels to prevent unwanted interference. Route the power cord through the right most cable channel. (see image 1 below).
2. Replace the cord cover ensuring the cords are running through the cable channels and not getting pinched. Loosely install six M5 hex cap screws, then tighten using 3mm allen wrench until the cover gasket is fully compressed to the cord gasket.
3. Replace the rear cover plate ensuring the cords are running through the cable channels and not getting pinched. Fasten the two hex screws on the rear cover plate using 3mm allen wrench to secure. Ensure the rear cover plate is fully compressed to the back of the display.

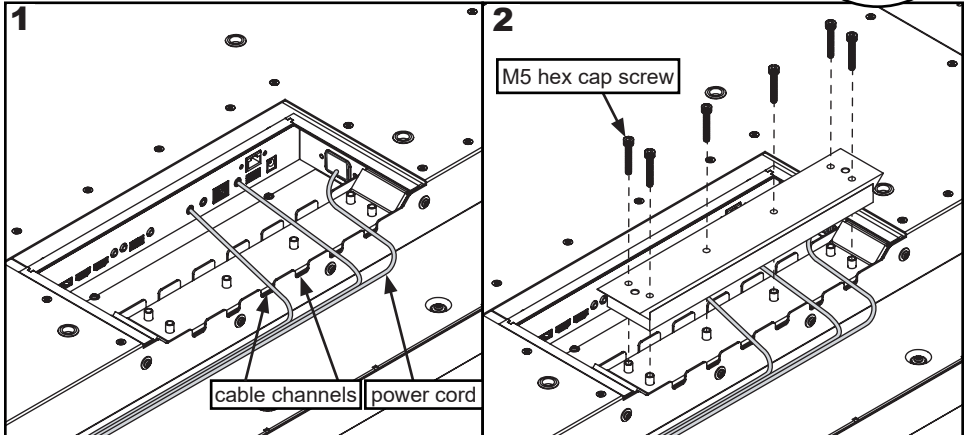
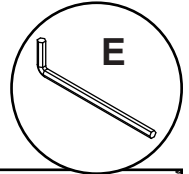

CAUTION

Failure to follow these instructions can result in the product being damaged or destroyed, voiding the warranty.

Optional: cable management

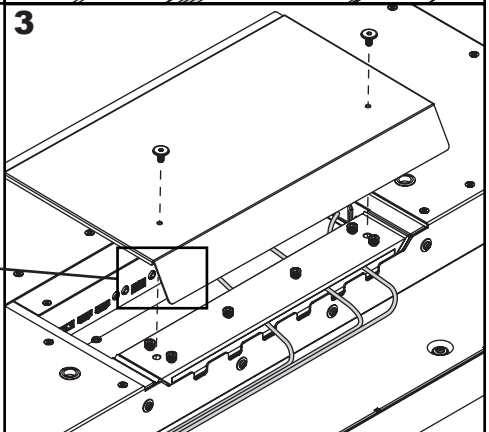
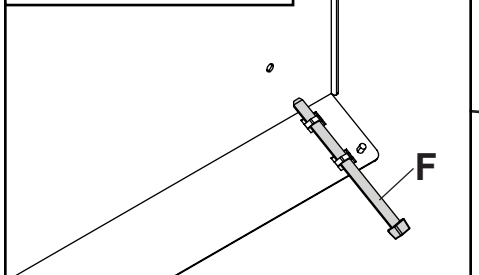

CAUTION

- Ensure cord bend radius does not exceed limits set by the manufacturer.
- Ensure cords are seated properly in the cable channels to avoid potential damage to cords when rear cover plate is installed.
- Do not remove lanyard that connects the rear cover plate to the display.
- Ensure cables exiting input compartment are routed downward when installing display in portrait orientation. If the installation requires the cabling to be routed upward, ensure that the cables are routed with a drip loop.

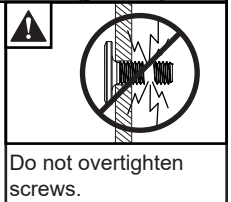

Connect to the Power Source

Connect power cord to GFCI outlet.

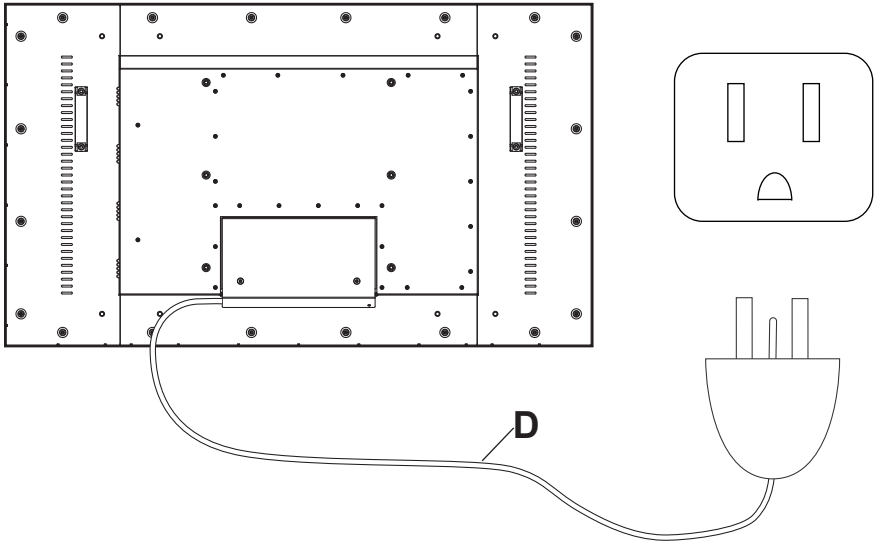

Removing Handles (Optional)

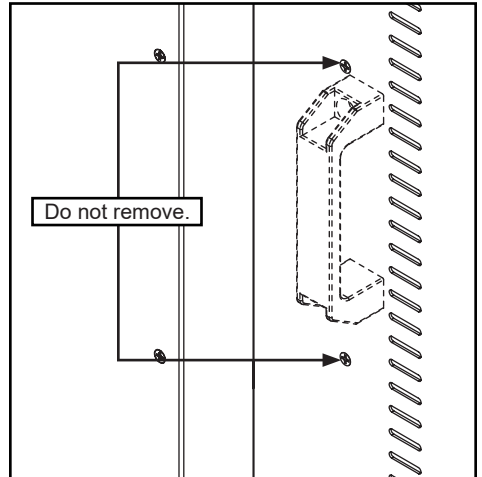
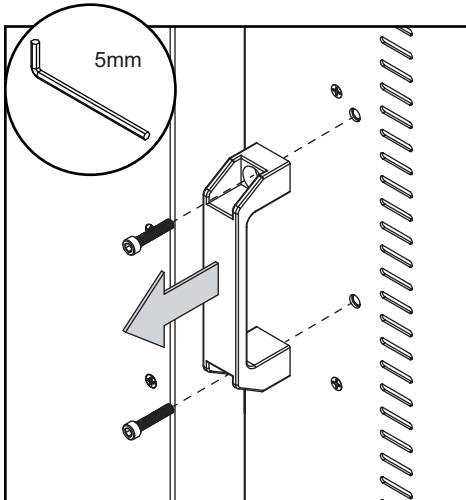

CAUTION

Do not remove the screws above or below the handles. Failure to follow these instructions can result in the product being damaged or destroyed, voiding the warranty.

Prepare the Display for Mounting

Install cords prior to mounting your display. Input panel may be obstructed once the display is mounted.

A mounting solution is sold separately. Contact your representative for an outdoor rated mounting solution for your particular application.

For your safety, only install an outdoor-rated mount that is suitable for the application and supports the weight of the display. When mounting a display outdoors, use proper environmentally rated mounts to ensure longevity in harsh environments.

Examine the chart below to determine the mounting specifications for your display:

Display Size	Mounting Hole Pattern	Mounting Screw Size
55"	VESA 400 x 200mm VESA 400 x 400mm	Four M8 x 18mm maximum thread
	Alternate 600 x 600mm Alternate 850 x 600mm	Four M8 x 12mm maximum thread

Display Size	A	B	C	D	E	F	G	H	I
55"	15.75" (400mm)	15.75" (400mm)	17.16" (436mm)	6.74" (171mm)	3.92" (100mm)	7.87" (200mm)	23.62" (600mm)	23.62" (600mm)	33.46" (850mm)

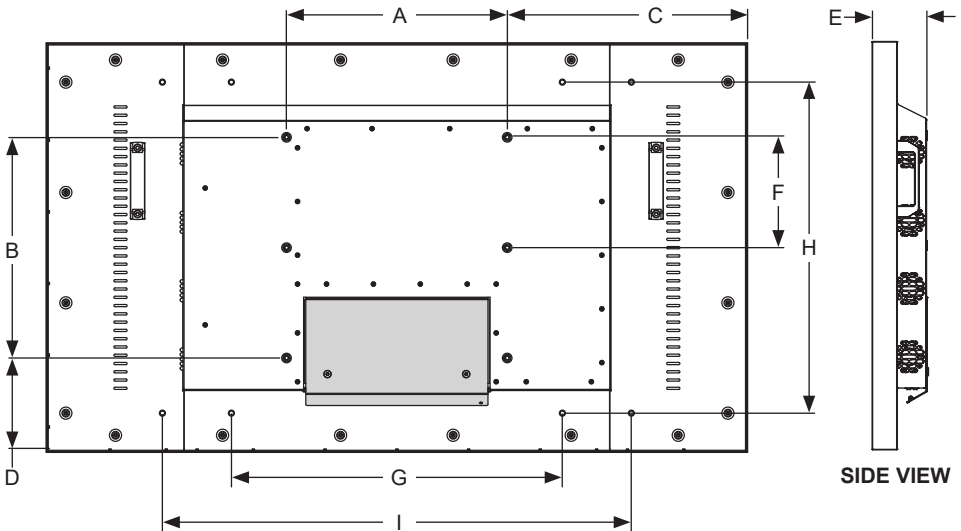

BACK VIEW

SIDE VIEW

Prepare the Display for Mounting

Display Size	A	B	C	D	E
55"	50.06" (1271mm)	29.23" (742mm)	47.70" (1212mm)	26.89" (683mm)	54.76" (1391mm)

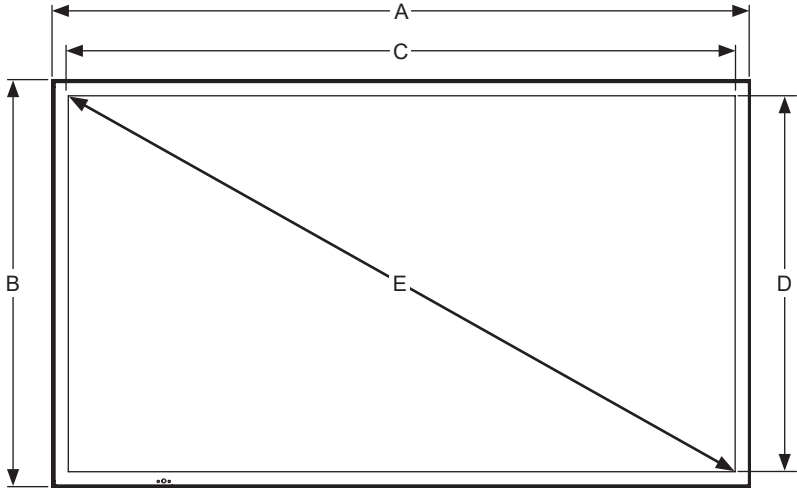

FRONT VIEW

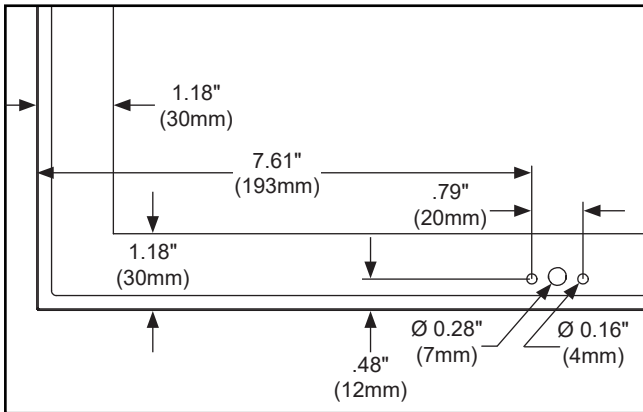

BEZEL / IR DETAIL VIEW

Remote Control Battery Installation and Replacement

The remote control is powered by two 1.5V AAA batteries installed at the factory.

If the Red LED light on the remote fails to illuminate when a button is pressed, the batteries may need to be replaced. Follow the directions below to replace the batteries.

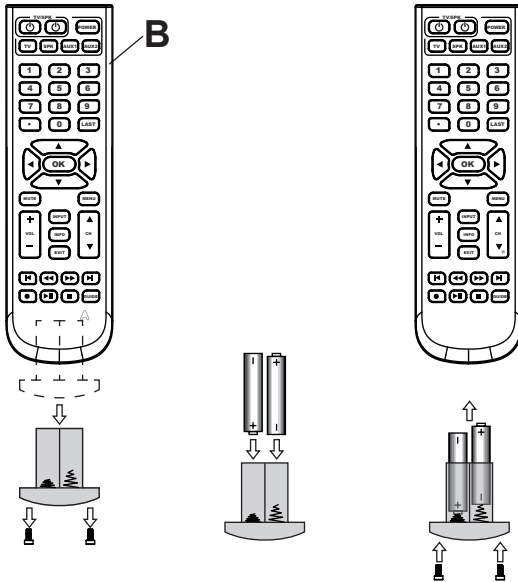

1. To remove the battery module of the remote control, remove the two screws on the end of the battery module. Slide the battery module out of the remote control.
2. Insert two new “AAA” size batteries into the battery module. Ensure the positive and negative marks on the batteries are correctly oriented with the markings on the inside of the remote control's battery compartment.
3. Slide the battery module back into the remote control and reinsert the two screws in the end of the battery module to maintain a waterproof seal (do not overtighten).

⚠ CAUTION

Incorrect usage of batteries can result in leaks or bursting. TRU-Vu recommends the following battery use:

- Do not mix battery brands.
- Do not combine new and old batteries. This can shorten the battery life or cause battery acid leaks.
- Remove dead batteries immediately to prevent battery acid from leaking into the battery compartment.
- Do not touch exposed battery acid as it may injure skin.
- Remove the batteries if you do not intend to use the remote control for a long period of time.
- Do not expose the batteries to excessive heat from sunlight, fire or other heat sources or batteries could explode.
- Fully tighten screws to maintain the ingress protection rating of the remote.

OPERATING INSTRUCTIONS

Power On/Off the Display

Power on your display using the remote control or the power button on the bottom, right-hand side of the display. The display will power on but image may not appear for several seconds as it completes its power up sequence.

Point the remote control at the IR sensor located at the bottom, left-hand corner of the display when in landscape, or the top left-hand corner when in portrait, then press the power button.

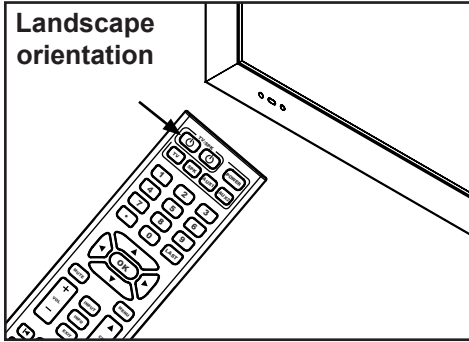

LED Light	TV Status
Solid	Off
Blinking	Boot up
Off	On

Onboard Controls

Direct Mode: Allows for quick access to source selection, volume settings and channel selection.

Menu Mode: Press the Menu button to access Menu Mode and activate the On Screen Display (OSD). For a description of OSD operation refer to the next section.

The keypad buttons are assigned as indicated in the table below.

Direct Mode	Menu Mode	
Channel Up	Up	→ [Up Arrow]
Channel Down	Down	→ [Down Arrow]
Menu	Return	→ [M]
Volume Up	Right/OK	→ [Up Arrow]
Volume Down	Left/OK	→ [Down Arrow]
Input Select	Input Select	→ [I]
On/Off	On/Off	→ [Power]

Navigating the On-Screen Menu

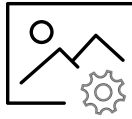

Picture

Picture Mode

Allows the user to alter the Brightness, Contrast, Color, and Sharpness of the video image to better match the look of the video against the environment it's being viewed in.

Standard
Dynamic
Soft
User

Color Temperature

Allows the user to match the natural lighting to better enhance how the video images appear to the user through the presets or the custom 'User' setting.

Normal
Warm
Cool
User

Advanced Settings

Aspect Ratio

Allows the user to change the size of an image to maximize screen space.
Note: Not all sources offer all preset options.

16:9 / Wide / Zoom / Cinema / 1:1 / 4:3

Noise Reduction

(for future use)

Dynamic Contrast

(for future use)

Color Range

Allows the user to set the color range manually or automatically.

Auto
0 - 255
16 - 235

Gamma

Allows the user to set different levels of how the dark images transition to bright images on the screen.

1 / 2 / 3 / 4 / 5

RGB Only Mode

When used, this feature will illuminate only the colored pixels chosen; when using this feature with a SMPTE Color Bar Pattern, the user will be able to adjust color accuracy of the display. (Note: This feature must be used with a content signal; with no content signal present, image strobing is normal.)

Off / Red / Green / Blue

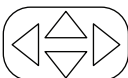

Navigate

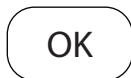

Enter



Exit



Return



Audio

<p>Sound Mode Allows the user to tailor the Treble and Bass frequency output of the Analog headphone jack. Note: These settings do not affect the TOSLink output (digital audio).</p>	<p>Standard Music Movie User</p>
<p>Balance: Alters the Left and Right speaker output. Note: These settings do not affect the TOSLink output (digital audio).</p>	<p>Default = 0 (centered)</p>
<p>Digital Audio Output Sets the output of the TOSLink port.</p>	<p>Off / PCM / Raw</p>
<p>Surround Sound Applies DSP to the Audio Output to simulate a wider audio staging area.</p>	<p>On / Off</p>
<p>AVL Allows the user to apply Automatic Volume Leveling to maintain a more consistent audio level regardless of the channel or program viewed.</p>	<p>On / Off</p>

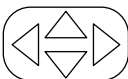

Navigate

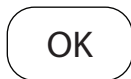

Enter



Exit



Return

Navigating the On-Screen Menu



Time

<p>Sleep Timer Allows the user to set a predetermined time for the display to power down.</p>	<table border="0"> <tr> <td>Off</td> <td>60 min</td> </tr> <tr> <td>5 min</td> <td>90 min</td> </tr> <tr> <td>10 min</td> <td>120 min</td> </tr> <tr> <td>15 min</td> <td>180 min</td> </tr> <tr> <td>30 min</td> <td>240 min</td> </tr> </table>	Off	60 min	5 min	90 min	10 min	120 min	15 min	180 min	30 min	240 min
Off	60 min										
5 min	90 min										
10 min	120 min										
15 min	180 min										
30 min	240 min										
<p>Daylight Savings Time Allows the user to set the TV to switch for Daylight Savings Time.</p>	<p>On / Off</p>										
<p>Time Format Allows the user to choose time format based on use-case.</p>	<p>12 Hour / 24 Hour</p>										
<p>Clock Allows the display to keep accurate time for scheduling. Time can be set manually.</p>	<p>Year (User Defined) Month: 1 - 12 Day: 1 - 31 Hour: 12am - 11pm Minute: 0 - 60</p>										
<p>Power Schedule 1 Allows the user to set a specific frequency, time, and date for the display to turn on and off automatically.</p>	<p>Off / Once / Everyday / Mon - Fri / Mon - Sat / Yearly</p>										
<p>Power Schedule 2 Allows a user to set a complimentary schedule to Power Schedule 1.</p>	<p>Off / Once / Everyday / Sat - Sun / Sunday / Yearly</p>										

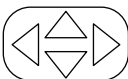

Navigate

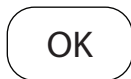

Enter



Exit



Return

Navigating the On-Screen Menu

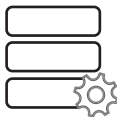

Setup	
Menu Languages Allows the user to set the default language of the OSD.	English / Spanish / French
Transparent Allows the user to set the transparency of the OSD Menu.	0% 75% 25% 100% 50%
OSD Time Allows the user to set the time at which the OSD Menu displays for (without a keystroke).	15 sec / 30 sec / 45 sec / 60 sec
Input Label Allows the user to define the title of the input label.	User Defined Up to 10 Alpha / Numeric / Symbol characters
System Settings	
Auto Power On Allows the user to set the display to return to a given power state chosen by the user.	On / Off / Memory
Power LED Allows the user to set the Power LED state when the display is off.	On / Off
Power Save Mode	
No Signal Power Off Allows the user to set the time for the display to power down if no content signal is present. Display will wake with Power On or Volume Up command.	1 min 2 min 5 min 10 min
No Signal Sleep Allows the user to set the display to go to sleep if no content signal is present. Display will wake when signal has been restored.	Off / On
Standby Mode Allows the user to keep the RJ45 port powered when in standby, which is required for monitoring and network control of the display. If the LAN port will not be used, the user can set the Standby Mode to Passive for power saving when the display is in standby.	Active / Passive

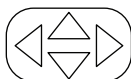

Navigate

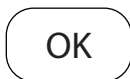

Enter



Exit



Return

Navigating the On-Screen Menu



Setup	
Backlight	
ECO Mode Allows the user to use a predetermined preset, custom preset, Ambient Light Sensor or a custom backlight schedule for the overall brightness of the display.	Min / Middle / Max / ALS / Personal Backlight / Custom Schedule
Backlight Allows the user to set any backlight level when using the "Personal" ECO Mode.	0 - 100
Custom Schedule Allows the user to set their own backlight levels. The user is able to set two backlight levels and set them to switch based on time of day.	Custom Schedule 1 & 2: 0 ~ 100 backlight intensity Time of day for schedules to switch between
Pixel Shift	
Pixel Shift Allows the user to set pixel shift to avoid image retention when using static images.	On / Off
Horizontal Range Allows the user to set how many pixels the image will shift horizontally.	2 / 4 / 6 / 8 / 10
Vertical Range Allows the user to set how many pixels the image will shift vertically.	2 / 4 / 6 / 8 / 10
Frequency Allows the user to determine how often the pixel shifting takes place.	1 min / 2 min / 5 min / 10 min / 20 min / 30 min

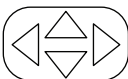

Navigate

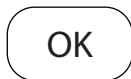

Enter



Exit



Return

Navigating the On-Screen Menu



Setup

Network Information Allows the user to get a visual readout of the IP information that the display has been issued. Display default is DHCP (IP Information can be viewed through the web page).	(Information Only)
Sensor Information Allows the user to get a visual readout of the sensors with the display that are used for monitoring the health and wellness (Sensor Information can be viewed through the web page).	(Information Only)
AV Technical Support Allows the user to see model number, serial number, and firmware revision.	(Information Only)
Restore Factory Default Allows the user to set the display to factory default settings.	Yes / No
peerConnect Allows the user to set the display to react to CEC (Consumer Electronic Control) for ease of navigation when using a source that complies with the CEC standard.	On / Off
Auto Source Switching	
Auto Source Switching Allows user to set the display to search for a content signal if the signal on the main source ceases.	On / Off
Priority Source Recovery Allows the user to initiate the display to look for a specific input defined by "Primary" and "Secondary"; If the Primary source is removed, the priority becomes what is chosen as "Secondary".	On / Off
Primary Source Allows the user to indicate the main source input.	AV / DP / HDMI 1 / HDMI 2 / USB Media / Component HDBaseT
Secondary Source Allows the user to set the secondary priority source if content ceases on the primary source input.	AV / DP / HDMI 1 / HDMI 2 / USB Media / Component HDBaseT
Software Update Allows the user to issue a software update through the USB media port when available.	Yes / No

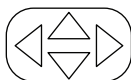

Navigate

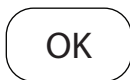

Enter



Exit



Return

Navigating the On-Screen Menu



Lock

Enter Password	Default PIN = 0000
Set Password Allows user to change the PIN for security.	(User Defined) 4 Digit numeric combination
Safety Lock On Allows the user to set the external power button to a fixed command.	Power On Only Power Toggle Button Lock
USB Auto Play Allows the user to set the USB as the priority source when powered on.	Off / Movie / Photo
System Lock Allows the user to lock out custom settings for content allowed.	On / Off
Input Block Allows the user to block any or all inputs; PIN is required if those inputs are recalled.	Block / Unblock

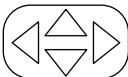

Navigate



Enter



Exit



Return

Media Functionality

1

[ENG] Insert USB flash drive into USB 2.0 Data port on the input panel of the display.

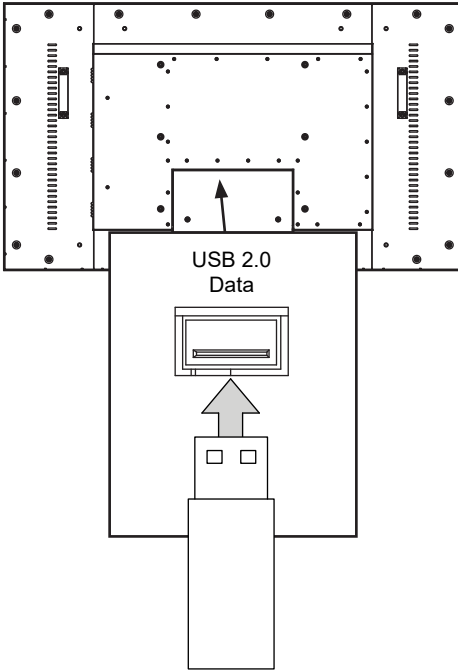

2

[ENG] Select USB source to access content.

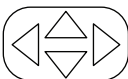
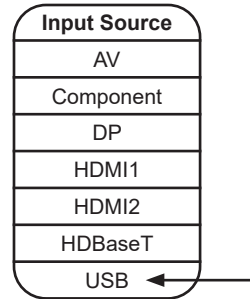

Navigate

OK

Enter

EXIT

Exit

MENU

Return

Media Functionality

3

[ENG] Select media type and folder where content is stored.

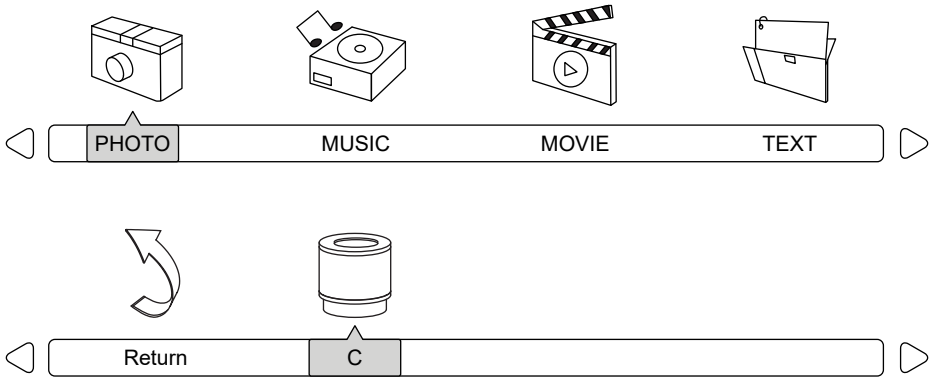

4

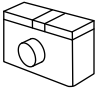

Photos – To view a single photo, select photo and press play. To view a slide show, select multiple photos and press play. Use on screen menu to control slide show.



Movies – To view a single video, select video and press play. To view a playlist, select multiple videos and press play. Use on screen menu to control playlist.



Music – To listen to a single song, select song and press play. To listen to a playlist, select multiple songs and press play. Use on screen menu to control playlist.



Text – To view a single text file, select file and press play. To view a playlist, select multiple files and press play. Use on screen menu to control playlist.

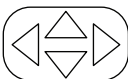
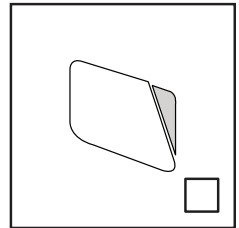
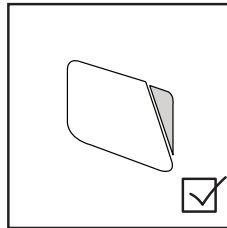
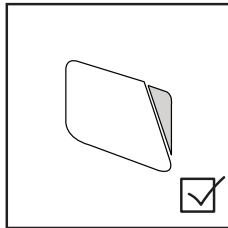
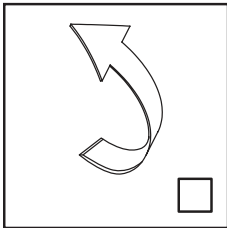

Navigate

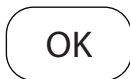

Enter



Exit



Hide Menu

(RS-232C) Serial Control of the Display

Attach an RS-232C cable (straight through type) to the supplied D-Sub RS-232C to utilize serial control function. Control via RS232 should only be utilized by experts familiar with RS232 programming.

(0):	A0, F0, 55, FF, 56, A9	Left:	A0, F0, 55, FF, 0C, F3
(1):	A0, F0, 55, FF, 42, BD	Menu:	A0, F0, 55, FF, 4E, B1
(2):	A0, F0, 55, FF, 43, BC	Mute:	A0, F0, 55, FF, 14, EB
(3):	A0, F0, 55, FF, 0F, F0	OK:	A0, F0, 55, FF, 02, FD
(4):	A0, F0, 55, FF, 1E, E1	Picture Mode:	A0, F0, 55, FF, 4B, B4
(5):	A0, F0, 55, FF, 1D, E2	Power Off:	A0, F0, 55, FF, AD, 52
(6):	A0, F0, 55, FF, 1C, E3	Power On:	A0, F0, 55, FF, AE, 51
(7):	A0, F0, 55, FF, 18, E7	Power On/Off:	A0, F0, 55, FF, 0B, F4
(8):	A0, F0, 55, FF, 45, BA	Right:	A0, F0, 55, FF, 05, FA
(9):	A0, F0, 55, FF, 4C, B3	Sleep:	A0, F0, 55, FF, 53, AC
AV:	A0, F0, 55, FF, ED, 12	Sound Mode:	A0, F0, 55, FF, 5B, A4
DisplayPort:	A0, F0, 55, FF, E4, 1B	Source:	A0, F0, 55, FF, 01, FE
Down:	A0, F0, 55, FF, 0D, F2	Surround:	A0, F0, 55, FF, C7, 38
Exit:	A0, F0, 55, FF, 1B, E4	Up:	A0, F0, 55, FF, 17, E8
HDMI1:	A0, F0, 55, FF, DE, 21	USB:	A0, F0, 55, FF, 57, A8
HDMI2:	A0, F0, 55, FF, DF, 20	Volume +:	A0, F0, 55, FF, 0A, F5
HDMI Toggle:	A0, F0, 55, FF, EC, 13	Volume -:	A0, F0, 55, FF, 40, BF
HDBaseT:	A0, F0, 55, FF, E0, 1F	Zoom:	A0, F0, 55, FF, 51, AE
Info:	A0, F0, 55, FF, 50, AF		

COM Settings	
Baud Rate	38400
Data Bits	8
Parity	None
Stop Bits	1

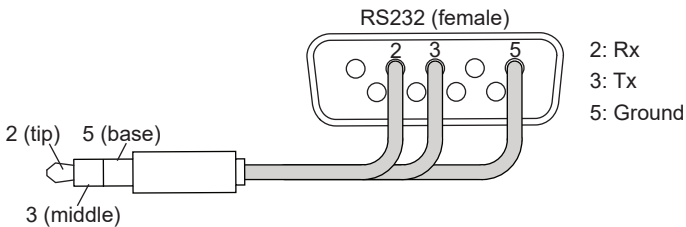

MAINTENANCE

Care of the Screen

Do not rub or strike the screen with anything hard as this may scratch, mark, or damage the screen permanently. Ensure that the display is installed in a location where it will be safe from abrasives and flying debris, which could damage the LCD panel. Never use ammonia or any product containing ammonia, as it will damage the anti-glare coating on the face of the display. Only use an approved screen cleaner to clean the display face. Unplug the power cord before cleaning the screen. Dust the display by wiping the screen and the cabinet with a soft, clean cloth. If the screen requires additional cleaning, use a clean, damp cloth. Do not use aerosol cleaners or solvents of any kind. Do not use any chemical such as paint thinner or benzene to clean the product's exterior. It may cause scratches on the surface, erasing proper indications, identification labels, or instructions on the exterior, which may cause misuse and improper operation of the product.

Cleaning the Exhaust

To clean the display's intake or exhaust, wipe off any debris in the grate using a moist towel. The grates may be sprayed clean with a low pressure hose, but high pressure washing is not permitted and may void the warranty. Do not cover the inlet or outlet for proper airflow, exhaust, and cooling.

End of Life Directives

In an effort to produce environmentally friendly products, your new display contains materials that can be recycled and reused. At the end of your display's life, specialized companies can minimize display waste by separating reusable materials from non-reusable materials. Please ensure you dispose of your display according to local regulations.

ENG	Warranty	ESP	Garantía	FRN	Garantie	DEU	Garantie	NEL	Garantie
ITL	Garanzia	ČES	Záruka	SLK	Záruka	POR	Garantia	TÜR	Garanti



TRU-Vu Monitors
925 E Rand Road, Suite 200
Arlington Height, IL 60004

847-259-2344

tru-vumonitors.com